

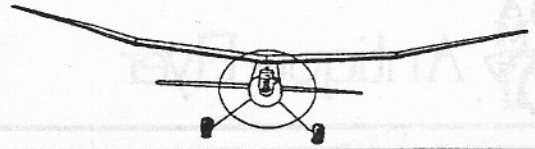

Antique Flyer



AMA CHAPTER #108

December 1994

Issue 148

November Chapter Meeting

By John Carlson

It was standing room only for several of the 30 attendees, our best recent turnout. Guests included Bill Bethke, master machinist, and his buddy Walt Paulholzer (also master machinist). They demonstrated Bill's 5 cylinder radial engine (more about this to follow). Our thanks to Remo Galeazzi for arranging this special event.

OLD BUSINESS

John Carlson forgot to bring examples of the SAM 27 welcome letter and the fact sheet now being sent to new members. Copies are reproduced elsewhere in this edition of the Antique Flyer so everyone will know what we are doing. Rocco Ferrario will have copies at the next meeting available for guests and for members who may wish to inform potential members of what SAM 27 is about. Tim Younggren suggested that the welcome letter package include copies of the SAM 27, 1995 Club Project (1/4 A Nostalgia), gas rules and possibly some plans. Tim Younggren distributed copies of the "final" version of the 1/4A Nostalgia free flight gas rules. These are also reproduced elsewhere in this newsletter. Rocco offered to copy plans for the T-bird model appropriate for this project and make these available to members at the December meeting. The plans shown in the November Antique Flyer scaled to about 150 square inches would be suitable for 1/4 A models. The interest expressed by attendees indicate we should have a good turnout of models for the four meets scheduled from June through September.

MECA COLLECTO

Ron Keil reported that the recent MECA Collecto held at the Western Aerospace Museum at the Oakland Airport had good attendance. Prices on certain engines

have taken a decided upward jump. We had planned to sell O & R T-shirts at the collecto but transportation problems delayed the seller to almost the closing. Two were sold however, and one was to the son of Mr. Rice, the "R" of O & R. We also sold 15 of the O & R decal sheets.

CHRISTMAS PARTY

By the time the newsletter arrives, the SAM 27 Christmas party, scheduled for Sunday, December 11th, may be history. However, it was decided to encourage attendees to bring Show and Tell items. A raffle of mainly non-modeling items will be held. Remo Galeazzi will purchase some prizes. At John Hlebcar's suggestion we will try a separate special raffle. Participation is optional. Those who wish will bring a wrapped gift, which will be for a male or female, modeling or not, in the \$5.00 to \$10.00 range. A number will be given to each participant. When a person's number is drawn, a gift is selected and then unwrapped. The next number drawn may select a wrapped gift or chose one from a previous winner. If a person's gift is taken, he or she selects another wrapped item and unwraps it. Another number is drawn, etc. This is an experiment and may or may not be repeated at future functions.

NEWSLETTER

The November Antique Flyer was produced by Debby LaFolette with guidance by Rocco Ferrario. Debby does desk top publishing professionally and used some very effective graphics. The production cost was \$75 for this first effort. After producing this first effort, Debby believes she could do future editions for less. This December issue is being produced by SAM 27 member Wes Funk and his wife Melanie who are seldom seen at our club meetings - they live in Truckee. Wes attends many competitive events and is often at Waegell Field. He also attends most of the meets held at the Schmidt Ranch. Wes and Melanie have graciously agreed to give this task a try. SAM 27 appreciates their efforts. Don Bekins will scan photos provided to him

and send copies of these and other material he receives to Wes. Jerry Rocha will continue with the meets schedule. Don will also keep the mailing list up-to-date on his computer.

BUTTON TIMERS

Rod Persons commented on the button timers featured in the inset on Page 6 of the November Antique Flyer. Rod reports that improvements, including a flange to facilitate mounting, are in the works and should be available soon. NFFS members can obtain (one person) timers through Fred Terzian at a discount (\$18.00 total vs. \$20.00 non-members).

NEW BUSINESS

Guest Speakers for February

Rod Persons advised that he has arranged with experts Rodger Gregory and Chuck Dorsett to give a presentation on Rubber Models at the February meeting to be held in Napa. Rodger and Chuck are from Walnut Creek. They are long-time modelers and are members of the Oakland Cloud Dusters and specialize in outdoor free flight models. Their emphasis will be on rubber break-in, winding, storage, lubrication, etc. We are looking forward to this presentation.

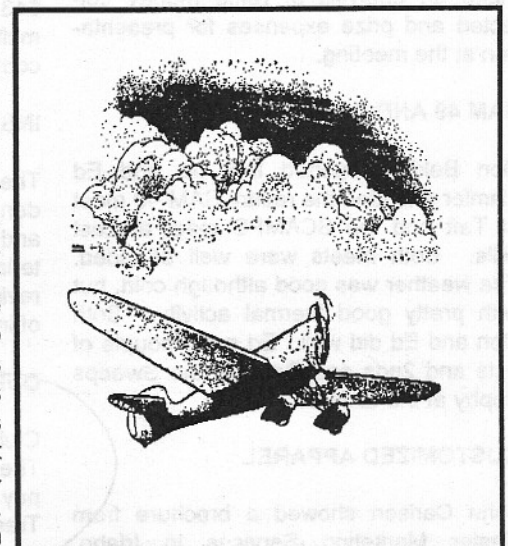

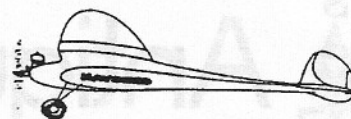

Redwood Middle School

DECEMBER MEETING

The December meeting will be held in Rocco's Redwood Middle School classroom. This and several future meetings will be held here to facilitate the attendance of some of the Junior Old Timers who have problems with distance and hours associated with the regular Novato meeting location. The meeting date is Wednesday, December 21st at 7:30 p.m. Following the meeting the gym will be available for flying rubber indoor models. Soooo, tune up and bring your Peanuts, Phantom Flashes, Hangar Rats or whatever. We had great fun last February. Let's do it again !!! We will have refreshments and a year-end raffle! The year-end raffle with the Don Parmenter Cleveland Viking R.C. model grand prize will be held at the December meeting. See you there.

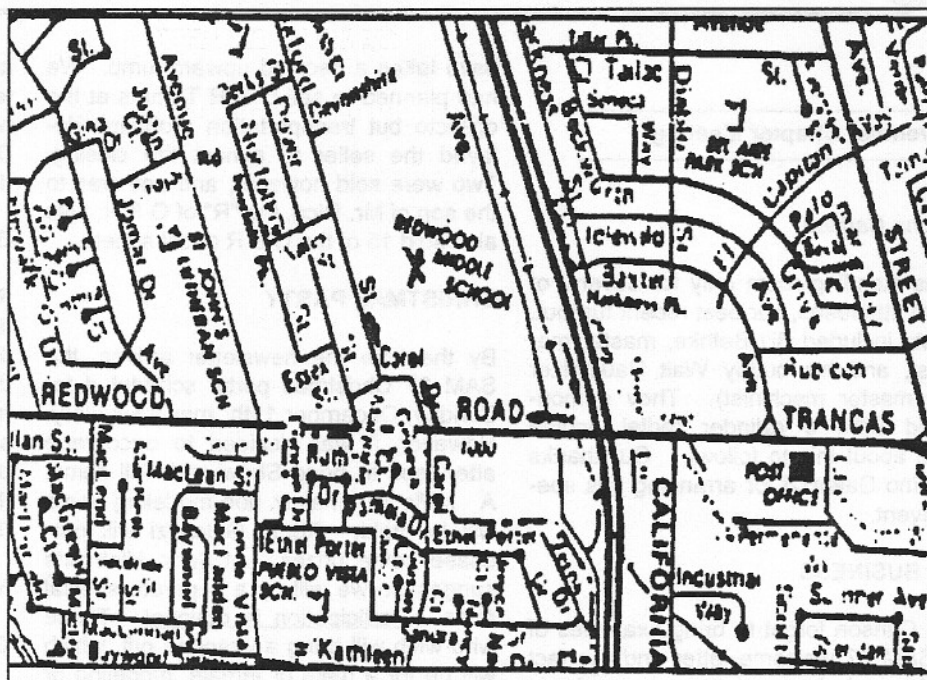

1995 RAFFLE PRIZES

Prizes for the monthly raffles are primarily those donated by members. SAM 27 supplements these with purchased prizes. In 1994, an ACE Receiver was raffled on alternate months. These were in addition to such standbys as CA, epoxy, tools, etc. Suggestions for 1995 include: Button Timers and 1/4 A Tee Dee engines suitable for club project models. We will ask for additional suggestions in December. John Carlson will make an analysis of raffle money collected and prize expenses for presentation at the meeting.

SAM 49 AND SCAMPS MEETS

Don Bekins reported that he and Ed Hamler attended the recent SAM 49 meet at Taft and the SCAMPS meet at Lost Hills. Both meets were well attended. The weather was good although cold, but with pretty good thermal activity. Both Don and Ed did well. Ed got a couple of 1sts and 2nds and Don got the Sweeps trophy at the SAM 49 meet.

CUSTOMIZED APPAREL

John Carlson showed a brochure from Kester Marketing Services in Idaho. They can make single or short runs of T-

North on Hwy. 29 through Napa
 Left on Redwood Rd.
 (1st light after Lincoln Overpass)
 2nd Right onto Carol Drive
 Right onto Oxford
 Ferrario's room is #C4

shirts, caps sweat shirts, etc. of any type of line art work in as many as four colors. There are no screen or set-up charges. A representative cost for T-shirts is \$13.00 for one color shirts and \$19.00 for multi color. Call 1-800-437-9146 for complete details and brochures.

INSURANCE

The Club recently received correspondence from the AMA regarding member and site-owner insurance and similar material from Sport Flyers. Rod Persons will review and advise whether any of this is of immediate concern to the Club.

DUES

Club dues for 1995 are now payable. There's no change, still \$15.00. Please pay at the upcoming meeting or mail to Treasurer, John Carlson.

GUEST PRESENTATION

Bill Bethke, assisted by Walt Paulholzer, showed, discussed and demonstrated the 5 cylinder 4-cycle radial engines Bill has constructed. Bill has owned and operated several machine shops over the years and has done specialty contract work for the aerospace industry. Walt is Bill's next door neighbor and also an accomplished machinist. Bill obtained the plans from Forest Edwards of Grass Valley who has CIC equipment and has made a 5 cylinder radial engine with a Roots blower as well as a 2 cylinder model. Bill, not having CIC equipment, did his the hard way - all manual. To maximize the use of each set-up, Bill made two engines plus a number of extra parts. Material was primarily 6061T6 aluminum. Valves were 303 stainless and the cranks were from 4130 steel.

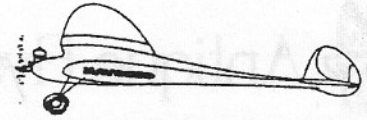

Push rods were made from drill rod. The pistons feature cast iron rings. Ignition is glow plugs and each engine has an integrated oil pump. The engines weigh about 5 1/2# and are about 10 - 12" diameter and develop about 3 1/2 HP at 6,000 RPM. Bill started work in January 1994 and has about 400 hours in each engine. Bill and Walt C-clamped one engine with its 20"+ prop to the table and, after clearing some of the attendees from the immediate area, attempted to start the little beauty with Walt swinging the prop. After a couple of minutes of futile prop spinning, Bill discovered he had the fuel line connected to the tank vent instead of the pick-up. With that corrected, a few more spins resulted in a successful start to the sounds of cheers by all present. The prop blast was waving the flags at the head of the room and sucking long cobwebs out of the rest of the room. The engine sound was great and not nearly as loud as some had anticipated. A few minutes of running produced a blue exhaust cloud in the room prompting shut-down and temporary departure outdoors for several members. We thank Bill and Walt for showing these beautifully crafted engines and also Remo for arranging the visit.

SHOW & TELL

TIM YOUNGGREN showed the fuselage of his 1/4 A model to demonstrate the mounting of one of the button D/T timers.

Tim made a mounting flange from balsa and plywood. Manufacturing modifications in progress will include an integrated mounting flange.

RAY MC GOWAN showed his entry into the 1/4 A Nostalgia project. It was a Campbell kit T-bird model beautifully framed and only awaiting covering. Ray reported that the \$27.00 kit was generally of pretty good quality. He also dispelled the myth that glow plugs were a relatively recent development. He showed a glow plug manufactured by the Edison Company, probably shortly after the turn of the century. The plug was about 10" long and Ray did not know what its original intended use was.

NICK SANFORD showed a wing he had covered with polyspan, a relatively new product. It is a tissue-like material with random polyester fibers. Polyspan is waterproof but does require dope to seal it, but much less than silkspan. The finished weights are comparable but polyspan is much stronger. It cannot be dyed in water but color dyes may be mixed with dope or dissolved in thinner and then sprayed onto the doped surface. Nick was very pleased with the appearance and handling of the product. A complete write-up is in the December 1994 issue of Flying Models and is available from Starline International of Arizona for \$15.00 per 20" X 12' roll plus \$2.00 postage and handling.

JUNIOR OLD TIMER BRIAN CASSAYRE showed a partially-framed Wasp 1/2 A model. Brian is developing into quite a craftsman. We hope to see the finished product soon.

DICK O'BRIEN showed a couple of .049 O.K. engines, one "new." Apparently someone located a stash of these new/old engines and is selling them for \$8.95 each. Dick hasn't run his as yet.

DON BEKINS has a computer program which can scan a photograph and produce a line drawing. The example he displayed was impressive. Don has plans for this process and will tell more in future meetings.

STEVE REMINGTON brought a 36" J-3 Cub kit by Herr Engineering. A very nice kit but the amazing part (to many of us who had not yet seen such) was the laser cut "print" wood. The cut edges were clean as a "whistle" and literally fell out of the sheet. The wing ribs even had triangular lightening holes (also falling out).

RAFFLE We had a goodly number of fine donated prizes in addition to those purchased by SAM 27. Brian Cassayre again demonstrated that the hand is quicker than the eye by drawing his own ticket first. He also did it last month winning one of the ACE Receivers. Everyone will be watching next time.

SAM 27 RAFFLE		NOVEMBER 16, 1994	TOTAL COLLECTED \$109.00
PRIZE	DONOR	WINNER	
Covering (glas cote)	Dick O'Brien	Don Bekins	
Covering (glas cote)	Dick O'Brien	Charlie Banks	
Cipolla Engine (2.5cc)	Tom Brennan	Nick Sanford	
Foo 2-U-2 (.020 kit)	Rocco	Brian Cassayre	
Allstate Desk Clock	Rod	?	
Hobby Knife	SAM 27	Don Bekins	
Files	SAM 27	Buzz Passarino	
Arounca Champ	SAM 27	Bob Waberly	
Speedster Kit	SAM 27	Steve Remington	
SE5A Kit	SAM 27	Dave Dann	
Pink Silk	Rocco	Charlie Banks	
Balsa	Don Bekins	Pete Samuelson	
Balsa	Don Bekins	Tim Mosberry	
Prop Balancer	Rod Persons	Dick O'Brien	
Prop Balancer	Rod Persons	Tim Mosberry	
Magnetic Tool Pick-up	SAM 27	Dick O'Brien	
Hemostats	SAM 27	Ray Mc Gowan	

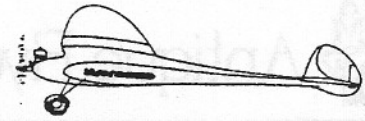

S.A.M. 27
1995 CLUB PROJECT

1/4 A REPLICA / NOSTALGIA FREE FLIGHT GAS

1. **PURPOSE:** To encourage all SAM 27 members to participate in the construction and flying of 1/4 A Replica/Nostalgia F/F gas models. The primary thrust of this project should be relaxation, participation, and FUN! FUN! FUN!
2. **DESIGN ELIGIBILITY:** Any free flight gas powered model airplane design that was produced and marketed in kit form or had plans published in a commercial publication prior to December 31, 1956 shall be deemed eligible. (John Pond's most recent Old Timer/Nostalgia catalog shall be the master list of eligible designs.)
3. **ENGINE ELIGIBILITY:** Any COX front intake valve or reed valve rear intake .010 or .020 shall be the eligible engines approved for this event. These engines may not be modified in anyway, except to make reed valve rear intake fuel tanks compatible with an alternate fuel tank system, if so desired.
4. **ENGINE RUNS AND FLIGHT LIMITS:** Engine runs and maximum flight limits shall be established at the discretion of the CD depending on the contest site and associated weather conditions. However the following engine runs and maximum flight limits are to be followed unless altered by the CD as described above.
 Engine Run: 10 Seconds.
 Flight Limit: 2 Minute maximum flight limits. (no fuse D/T's)
5. **REGULATION OF FLIGHTS:** A total of five (5) attempts shall be allowed to make three (3) official flights. An official flight shall be any official attempt of thirty (30) seconds or more in duration. Flyoff flights which may be required to declare a winner shall comply with the same engine run and flight limits as established for the original (3) official flights. All flights shall be Hand-Launched.
6. **MISCELLANEOUS:**
 - A. There will be no weight limits to the model.
 - B. There will be no wing area limits to the model.
 - C. Any size or shape of propeller may be used.
 - D. Any fuel may be used.
 - E. Scaling of designs up or down is permitted.
 - F. Two (2) models shall be permitted per contest. Each must be entered separately. However, only one of the models shall be eligible to win a first through fifth place.
 - G. The builder of the model must fly his own model. No Proxy flying is permitted.
7. **PROOF OF ELIGIBILITY:** The authenticity and proof of compliance of questionable model design shall be the sole responsibility of the contestant. However, the CD shall retain final authority in all considerations.
8. **CONTEST DATES AND DETERMINATION OF WINNERS:** There will be four (4) contests held in 1995. They will be held at the Lakeville field on the first Saturday of the months of June, July, August, and September, (unless otherwise agreed to by the Sam 27 membership at their regular meeting held on the month before the next scheduled contest). Contests will begin at 8:00am with the last official flight no later than 12:00 noon. There will be prizes for the top three finishers (i.e. balsa, props, fuel, etc.) at each of the monthly contests. Monthly contest winners will be assigned points as follows:

1st Place	5
2nd Place	4
3rd Place	3
4th Place	2
5th Place	1

Sweepstakes winner will be the contestant with the highest point total of the three (3) entered contests. Contestants must enter three (3) of the four (4) scheduled contests to be eligible for the sweepstakes prize. Only the points earned from the three (3) entered contests will be used in determining the point totals.

The sweepstakes prize will be determined by the SAM 27 membership at the February 1995 regular meeting. An entry fee of Five (\$5) dollars will entitle a contestant to participate in all four scheduled contests. If enough Juniors participate (i.e. three or more), separate prizes could be established for them. This would be at the discretion of the SAM 27 membership. Otherwise, they will compete in the open category.



The following are examples of the SAM 27 welcome letter and fact sheet which are proposed to be given to prospective members as mentioned in Old Business earlier in this newsletter. The originals are on two separate pages and contain graphics which don't appear here due to the need to conserve space.

JOHN CARLSON
353 LAS CASITAS COURT
SONOMA, CA 95476
(707) 996-8820

Dear -----:

Welcome to SAM 27!

Enclosed is our SAM chapter's name tag/membership card. You will be receiving our newsletter, the **Antique Flyer** each month. Also enclosed a membership roster, which we hope will be useful in communicating with other modelers in our farflung old timers' group.

Enclosed is a club decal and a replica of the original Ohlsson Powered logo, which is the basis for our SAM 27 logo. We are also including a sheet which will give you an overview of what SAM 27 is, how it operates and the activities it promotes. Again, we are happy to have you as a member of our growing SAM 27 old timers group, now more than 75 strong. We hope you will join us at our monthly meetings, regular fun-flys and our big contest, the **Crash & Bash**, held in the fall of each year.

Thermals!

John Carlson, Secretary

Welcome to SAM 27! SAM 27 was formed in 1976. Five of the founders are still active members. Membership has varied from a low of 7 to a current 75 members. About 50 are from the north bay, San Francisco area, several are from other parts of the US and foreign countries; the balance are from other areas of California. SAM 27 members include the newly elected SAM national officers of President, Don Bekins, and Western VP, Ed Hamler.

SAM 27 is a multi-interest old timer modeling club with emphasis on R/C assist. A number of members also participate or specialize in free flight, rubber indoor and outdoor, hand launch gliders and thermal and slope R/C gliders. Several members are major competitors with many trophies from regional and national contests, and include some past and present record holders. A number of our members are MECA engine collectors. All are encouraged to join the Society of Antique Modelers. An application is enclosed.

SAM 27 sponsors a very successful Junior Old Timer Program with about 15 current members under the age of 20. The program includes several levels of building and competing with HLG through rubber stick and cabin, to LER/ Texaco, free flight, or R/C. The club provides assistance in the way of materials and mentoring.

Meetings are held on the 3rd Wednesday of each month, usually at the Novato Fire Department training room on Atherton Ave. Occasionally special locations are selected as a meeting site. An average of 25 to 30 attend the meetings which are lively and entertaining. In addition to covering business matters, the meetings include Show&Tell, a raffle and usually a technical presentation by a member or other person with a particular expertise.

An illustrated monthly newsletter of professional quality keeps members informed on past, current and future events, and frequently contains editorial material and technical articles.

SAM 27's flying site off the Lakeville highway southeast of Petaluma in Sonoma County is the location for several well attended contests and fun flys during the year including an O/T rubber contest and 1/2 A Texaco Postal meets. The site is sufficiently away from housing be permit to flying of unmuffled ignition engines. Many members use the site for test flying both R/C and free flight models.

In addition to meets at the Lakeville site, SAM 27 sponsors a annual two day meet known as the Crash & Bash with mostly R/C assist events. For the past several years the C&B has been held at the Elk Grove ranch of Loren and Miriam Schmidt, members of SAM 27 as well as SAM 30. A more pleasant site for a meet would be hard to find. There is much open space for flying edged by lawns and shade trees. Overnight camping, motor homes and trailers are welcome. Friday and Saturday dinners, and lunches each day are features of the contest. Participation of 40 to 55 contestants as well as family and friends make this an old timer meet to be remembered.

Club activities are funded by member dues of \$15 per year and several fund raising events. These include a raffle at the monthly meetings, with a year end prize of considerable value. A major fund raiser is the annual contest, the Crash & Bash. Sources are event fees, the lunches and dinners as well as a raffle with an attractive grand prize which in 1994 is a complete, ready-to-fly Ohlsson 60 powered "Riser Rider" model, including several trophies and ribbons it has won. The club also sells Ohlsson & Rice logo T-Shirts, SAM 27 polo shirts, and special O&R logo decals. These fund raisers help to support the club's non-profit youth activities as well as keep the annual dues low and maintain solvency.

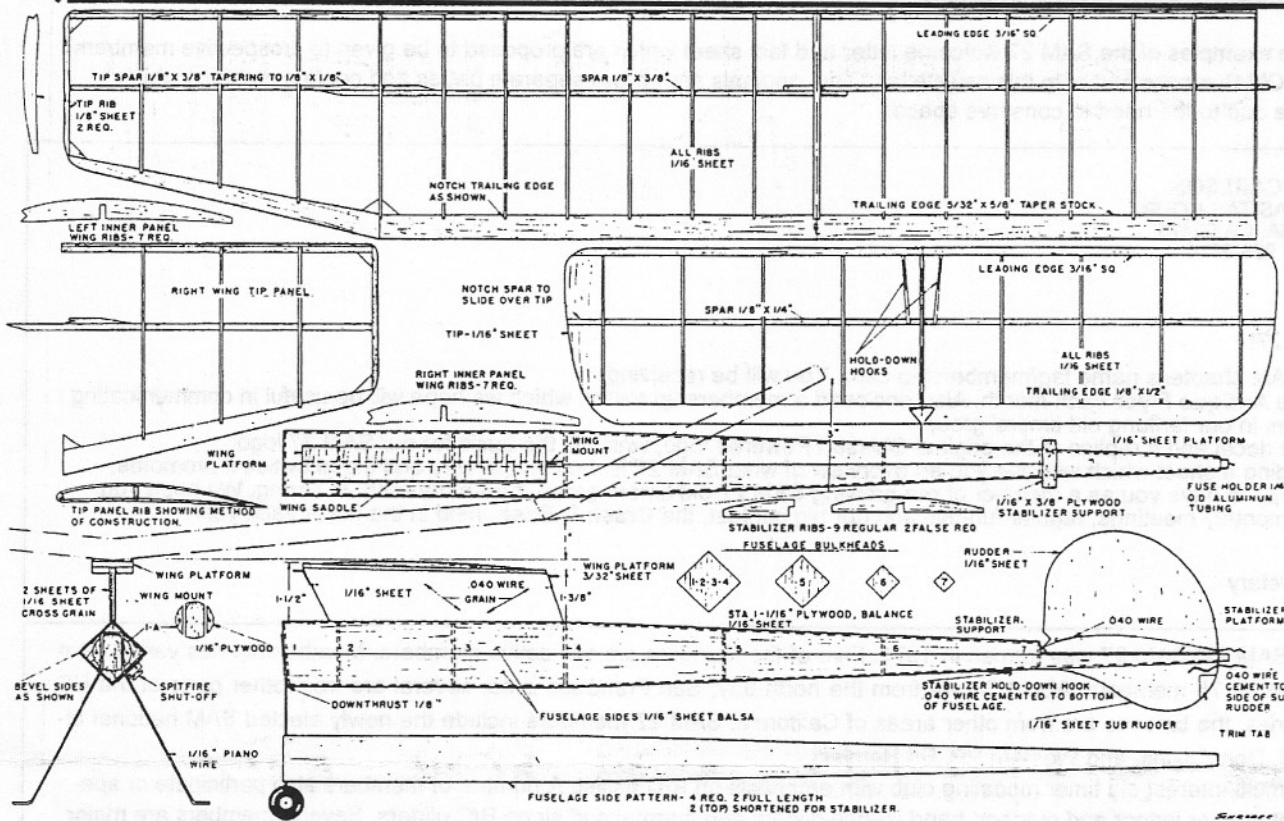
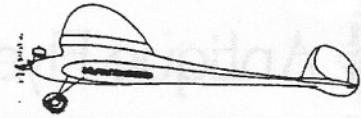

1952

September 1952 Model Airplane News Published this 38 in. wing span **ZEPHYR** by Sal Taibi. It is another possibility for the 1995 Club Project.

Included this month is a separate un-numbered page with full size plans for a De Havilland Chipmunk. Designed by H.G. McEntee, and published in the February 1958 issue of Air Trails. Build one from your scrap box in an evening or two and bring it to the next meeting to fly it in the gym.

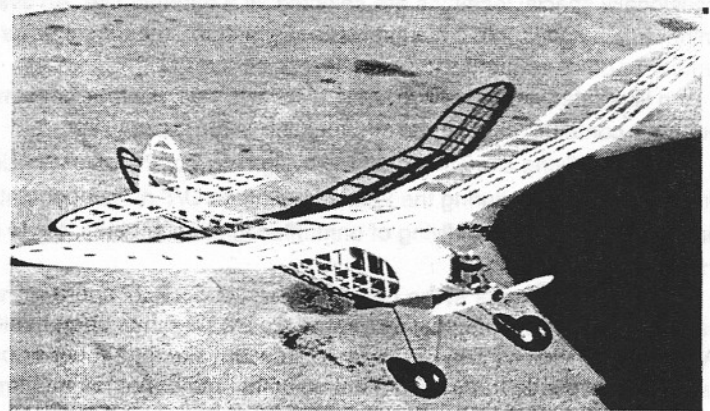
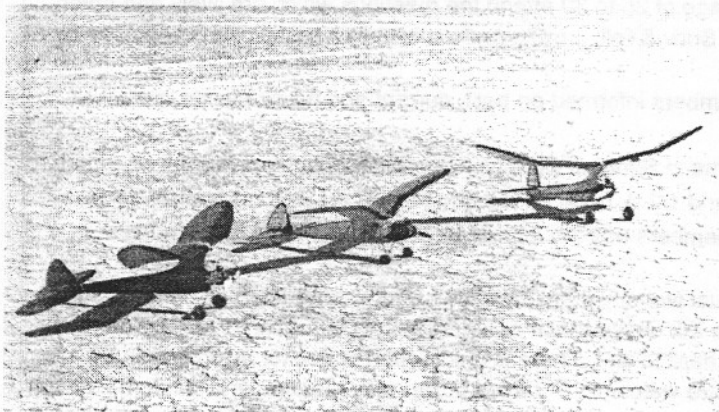

Megow Ranger, O&R 23. Modelcraft Spook 48, Bantem 19. and Playboy Jr. O&R 29 All models are free flight. The photo was taken at Stagecoach Dry Lake, Nv. Tom Carmon built the two on the left, the Playboy Jr. was built by Wes Funk.

The bare bones of a Playboy Jr. built from original Cleveland plans, O&R 29 for power about 1984. It was entered in the 1985 SAM Champs at Medera, in class B free flight.

**TRANSISTORIZED IGNITION SYSTEM
ADAPTED FROM DESIGN BY J. LANGE**

IGN. PACK

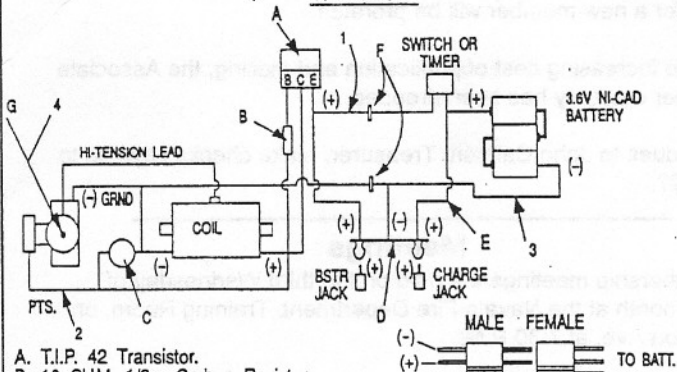

- A. T.I.P. 42 Transistor.
 - B. 10 OHM, 1/2w. Carbon Resistor.
 - C. 470 Pf Capacitor (Condenser).
 - D. Common Ground (-) for jacks to housing.
 - E. Positive (+) to center posts of jacks.
 - F. Deans Pin disconnect-see detail.
 - G. 10K. carbon resistor - RC only.
- F. DETAIL
(AVOIDS POSSIBLE SHORTING-
REVERSAL = NO CURRENT CONTACT)

PACK INST.

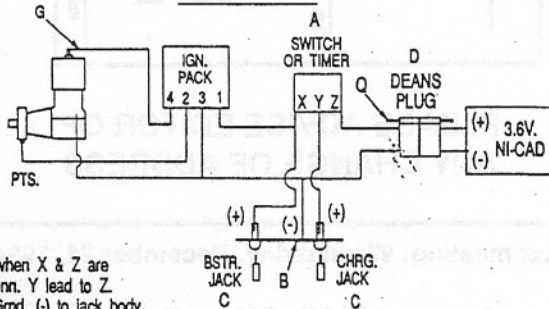

- A. Y is "on" when X & Z are "off", or conn. Y lead to Z.
- B. Common Grnd. (-) to jack body.
- C. (+) to center pins of jacks, (-) to body of jacks.
- D. Center pin is (+), outer pin (-). Reversal puts (-) pin in blank "Q", avoiding short circuit.



One thing about being a new editor, I need pictures with notes. Who took the picture, who and what are in the picture and where and when it was taken. Please send me what you would like to see in your Newsletter, I'll be sure and return all photos to their owner. Until I get some new material you will be seeing some of my own pictures.

Above: Playboy Jr. with Ohlsson 29, silk coverd. Taken at Stagecoach dry lake, about 25 miles east of Carson City, Nv.

Below: My 1/2 A Free Flight, was published in Model Builder by Bob Stalick, April 1986. It has been one of my most consistent models, and has won a lot of events over the years for me. Some of which are the U.S. Free Flight Championships, Taft Ca. Southwest Regionals, Eloy Az. Northwest Regionals, Tangent Or. Northern California Free Flight Champs. Sacramento Ca.

Merry Christmas

FUNKY FLYER

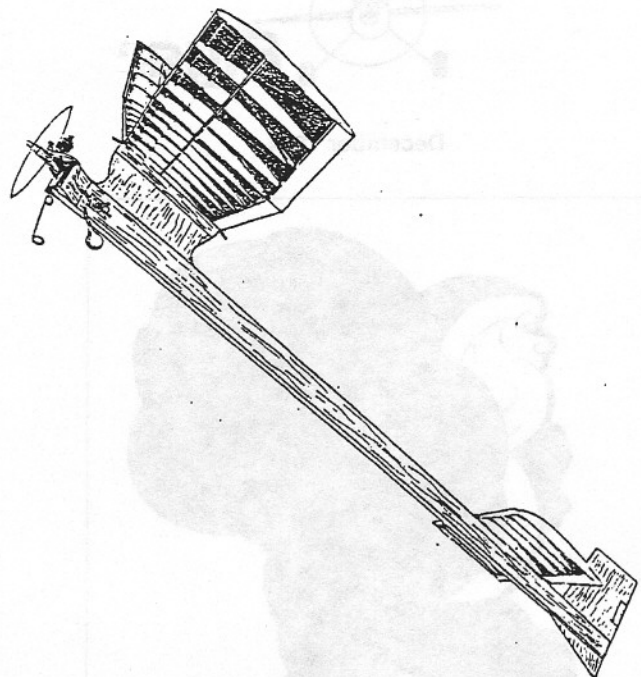

✂

SAM 27 MEMBERSHIP APPLICATION

Return to : John Carlson
353 Las Casitas Court
Sonoma, Ca. 95476

Please Print

Name _____ Wife's Name _____

Address _____

City _____ Zip _____

Home Phone _____ Work # _____

AMA# _____ SAM# _____

SIGNATURE _____ DATE _____

PLANS ARE FULL SIZE

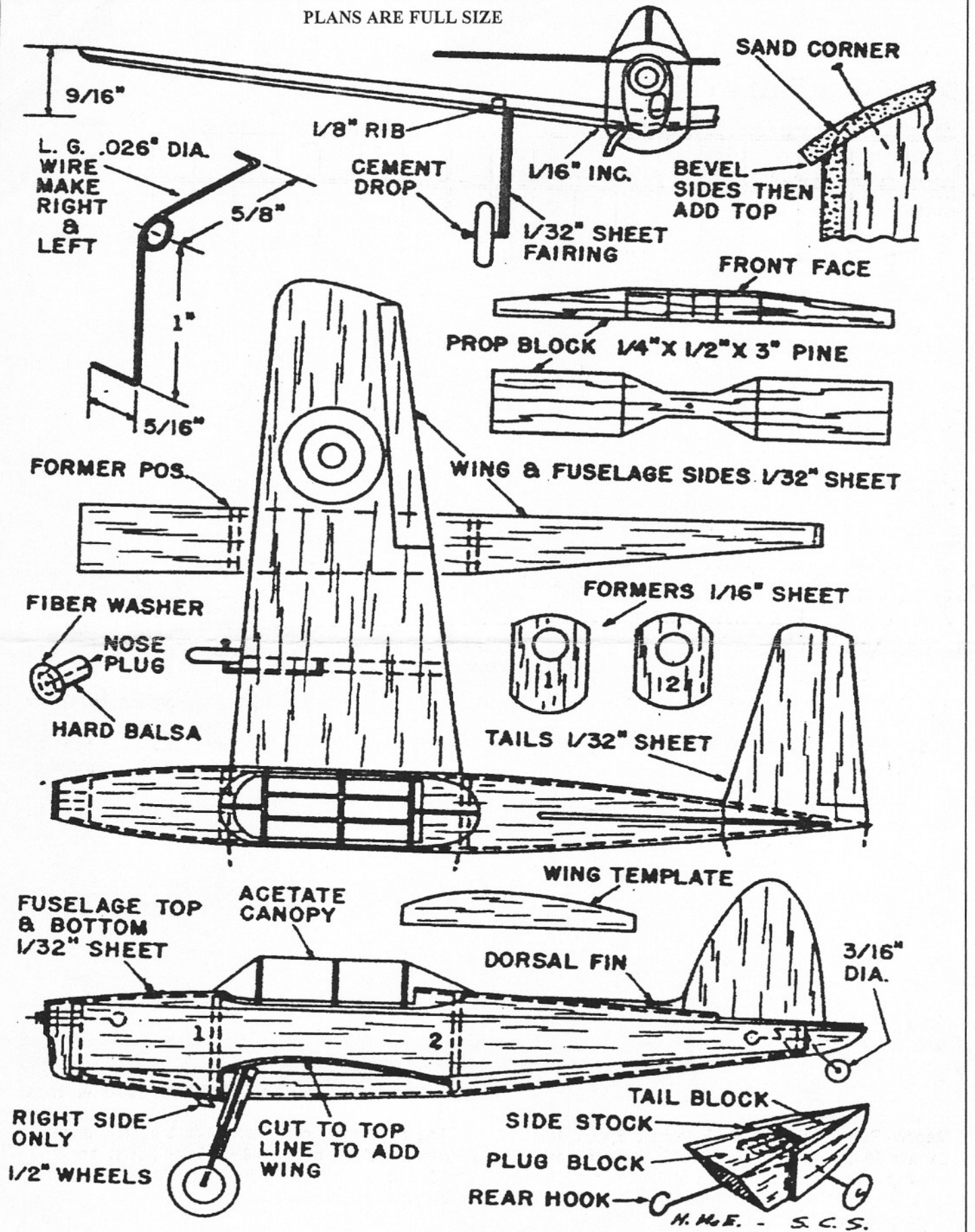

(Air Trails Feb. 53).



AMChapter #108

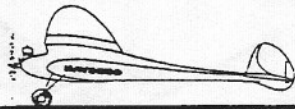

OFFICERS

President:

Rod Persons (707) 894-5788
2063 Lone Oak Ave.
Napa, Ca. 94558

Vice President:

Tim Younggren (707) 433-9317
240 Sun Court
Healdsburg, Ca. 95778

Treasurer:

John Carlson (707) 996-8820
353 Las Casitas Ct.
Sonoma, Ca. 95476

Contest Director:

Ed Hamler (707) 255-3547
85 Bellevue Ave.
Belvedere, Ca. 94920

Editor:

Wes Funk (916) 587-2785
P.O. Box 8241
Truckee, Ca. 96162

P.O.Box 8241, Truckee, Ca. 96162

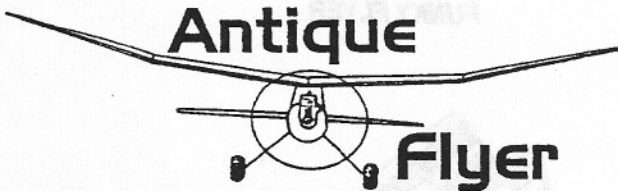

December 1994



94502-7015 30

Membership

Membership is \$15 for the calendar year. After February, the dues for a new member will be prorated.

Due to increasing cost of publication and mailing, the Associate Member category has been dropped.

Send dues to John Carlson, Treasurer. Make checks payable to SAM 27.

Meetings

Membership meetings are held on the third Wednesday of each month at the Navato Fire Department, Training Room, on Atherton Ave. at 7:30 P.M.

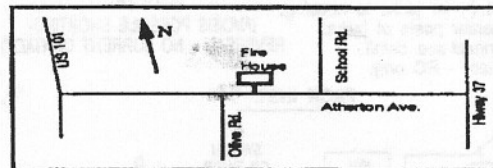

PLEASE ADVISE EDITOR OF ANY CHANGE OF ADDRESS

Next meeting: Wednesday, December 21, 1994

Redwood Middle School Room C4



FIRST CLASS MAIL

Steve Harrington
1034 Melrose Ave.
Alameda, CA 94502

